

- /rectangular 3.5 m
- /walk-in cold store
- /longitudinal draft counter
- /3 open-up sales flaps

3500 K



Export Australia



Bar and Event Trailer

3500 K

Handling

Opening/closing 1 person app. 5 min.

Weights

Gross vehicle weight max.	1.800 kg
Tare weight basic type app.	1.400 kg
Payload basic type app.	400 kg

Dimensions

Overall (without roof display) app.	5.560 x 2.460 x 2.600 mm
Rectangular sales area app.	2.620 x 2.400 mm
Interior standing height app.	2.100 mm
Covered sales area app.	4.750 x 5.060 mm
Cold store interior app.	810 x 2.220 x 2.000 mm
Surrounding counter length (3 sides) app.	9.500 mm
Longitudinal draft counter app.	2.560 x 500 mm

Standard features

hot galvanized chassis with single axle, height adjustable drawbar, EU standard overrunning and parking brake, 12 V EU standard lighting system, reinforced jockey wheel and support legs, complete bodywork with roof and open-up flaps made of insulated sandwich panels, entrance door at the rear, PEKI Alustar all-aluminum system floor, full insulated cold store with entrance door at the front and passing door to the sales area, 230 V 16 A 50 Hz reinforced cooling machine, 2 step interior and folding counters with optimum working and guest height, surrounding guest counters in rounded design, longitudinal draft counter on the left with brushed NCS covering with sink, cold water tap and drip tray, longitudinal working counter on the right with space for bottle chest cooler or refrigerator, 230 V 16 A basic electric system with German standard plugs, supply for fresh and used water with connections PVC corner covers, ...

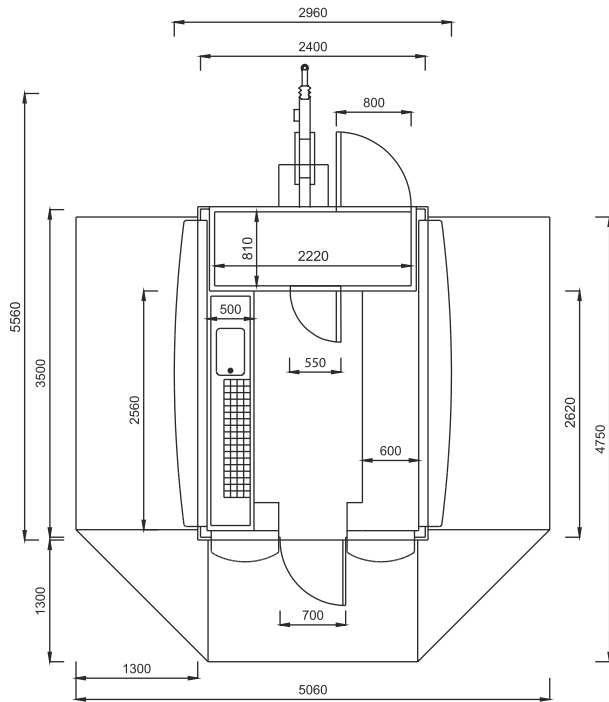

All weights and dimensions are app., in basic version as described above and according DIN 70020. We reserve the right for changes and modifications without prior notice. Pictures show special equipment. Errors and omissions reserved. © PEKI 2025



PEKI GmbH
Vehicles and Systems for Events
Am Neuhaus 2
DE-54317 Osburg/Trier Germany

Phone: +49-6500-9141-0
Fax: +49-6500-9141-83
e-mail: info@peki.com
www.peki.com

